

# SECURITY PRODUCTS CATALOG

---

INGENUITY | INDUSTRY | INTEGRITY



**AMERICAN  
LOCK®**



AMERICAN  
LOCK

# TABLE OF CONTENTS

## The American Lock® Advantage

The Trusted Name in Security . . . . .	3
BumpStop® Advanced Cylinder Technology . . . . .	3
Edge® Key Control System . . . . .	3

## Custom Ordering and More

Make-To-Order Capability . . . . .	4
Keying Options . . . . .	4
Shackle Options . . . . .	4
Custom Marking . . . . .	4
Key Charting . . . . .	4
Lock Express . . . . .	4

## Solid and Stainless Steel Padlocks

Rekeyable Hidden Shackle Padlocks . . . . .	6
Locking Bolt . . . . .	6
Rekeyable Solid Steel Padlocks . . . . .	7
Rekeyable Solid Stainless Steel Padlocks . . . . .	9
Non-Rekeyable Solid Steel Padlocks . . . . .	9
Blade Cylinder Solid Steel Padlocks . . . . .	10
Tubular Cylinder Solid Steel Padlocks . . . . .	10

## Solid Brass Padlocks

Rekeyable Solid Brass Padlocks . . . . .	12
Non-Rekeyable Solid Brass Padlocks . . . . .	13
Blade Cylinder Solid Brass Padlocks . . . . .	13

## Solid Aluminum Padlocks

Safety Lockout Padlocks, Identification and Hasps . . . . .	15
Rekeyable Solid Aluminum Padlocks . . . . .	16
Non-Rekeyable Solid Aluminum Padlocks . . . . .	16

## Government Padlocks . . . . . 17

## Door Key Compatible Cylinders and Padlocks

Door Key Compatible Padlocks . . . . .	19
A3650 Series Multi-Cylinder Padlock . . . . .	20

## Service Kits . . . . . 20

## Interchangeable Cores and Padlocks

Interchangeable Core Padlocks . . . . .	21
Small Format Interchangeable Core Padlocks . . . . .	21
Large Format Interchangeable Core Padlocks . . . . .	22

# THE AMERICAN LOCK® ADVANTAGE

## THE TRUSTED NAME IN SECURITY

Since 1912, American Lock® has been the brand of choice in security products. Here are the reasons why.

**Ingenuity.** With more than 100 years of precision machining and quality manufacturing, American Lock products are, quite simply, not only strong but smart. They exceed commercial industry standards and defeat attempts to breach security at any level. In anticipation of any new threats that develop, our lock technology evolves, offering cutting-edge innovations that best serve our customers' needs.

**Industry.** The toughest padlocks available, American Lock products serve industry, government and commercial users worldwide. Our locks not only stand up to attack, but can also withstand years of abuse from the harshest environments—ideal for industrial use. The strength and endurance of our premium, hard-working locks is what has earned them the distinction of “The Locksmith’s Lock.”

**Integrity.** American Lock is proud of our record of serving our customers with the greatest integrity and of earning their trust for nearly a century. Throughout the years, we’ve been entrusted with protecting the most valuable assets of businesses, utilities and municipalities with our high security products. That speaks volumes about the confidence our customers place in us. As our locks endure, so does our customers’ trust in American Lock.

The American Lock advantage doesn’t stop at just building the toughest and most durable locks in the marketplace. We take security to a new level with the following innovations and services.

### BUMPSTOP® ADVANCED CYLINDER TECHNOLOGY

Counter the ever-growing security threat of lock “bumping” with this patented technology. The BumpStop® feature prevents the transfer of force from the bump key to the pins and blocks rotation of the cylinder so that the lock remains locked. A reverse rake tapered driver pin, high performance spring and precision tolerance chamber make these locks four times more resistant to bumping than the toughest proposed anti-bump industry standard.



### EDGE® KEY CONTROL SYSTEM

Prevent unauthorized key duplication with this cost effective, patented system. An innovative cylinder design with an additional locking mechanism creates numerous one-of-a-kind “virtual keyways.” This means that all operating keys are unique to a facility and new key blanks are only available at authorized dealers. Edge® 1539 cylinders are available for most American Lock padlocks.



**AMERICAN  
LOCK®**  
100<sup>TH</sup> ANNIVERSARY  
1912-2012

## CUSTOM ORDERING AND MORE

The American Lock advantage goes beyond product. Our custom order capabilities, keying and shackle options, custom marking, key charting and Lock Express® service allow us to create tailored security solutions to meet each customer's specific needs.

### MAKE-TO-ORDER CAPABILITY

We custom build American Lock security products to our customers' specific requirements. Choices include the following.

#### KEYING OPTIONS

American Lock® offers full keying flexibility. Over 60 padlock, door hardware or small format interchangeable core keyways are available. Choose from:

**Keyed Different (KD)**—Each padlock has its own key. This is the standard for all products unless requested otherwise

**Keyed Alike (KA)**—Padlocks can be opened with the same key, offering convenience and eliminating multiple keys for those who use numerous padlocks.

**Master Keyed (MK)**—In this system, one key can access one or more separate groups of padlocks or cylinders that are each operated by their own change keys. This is ideal for supervisor access.



Plus, American Lock offers key retaining or deadlocking options, which prevent the padlock from being left unlocked, as the keys cannot be removed while the padlock is open. And we also offer restricted keyways—restricted key systems with factory controlled keys that aren't available at a locksmith, so there is less chance of unauthorized key duplication.

#### SHACKLE OPTIONS

American Lock offers a wide range of shackle options, including shackles in extra lengths, chain attachments and various materials, including hardened boron alloy, brass and stainless steel.



#### CUSTOM MARKING

These options include laser engraving or hard stamping of company logos or any alphanumeric characters for safety lockout purposes, employee locker identification or company or institutional/school branding.



#### KEY CHARTING

This service maintains the series of key numbers for five- or six-pin padlocks. The keys are blind coded and the key numbers are maintained in a chart. Using one of these systems, a user can simply call to order the next key number in the sequence or a replacement key.

The charting system is perfect for those who have a safety lockout application at a medium or large facility, as we can offer 80,000 unique key cuts per plant location—eliminating the chance of duplication, helping to prevent lockout related accidents, and making it easier to maintain OSHA requirements. For more information on key charting, please see the American Lock price book.

#### LOCK EXPRESS PROGRAM

For those who need their orders quickly, we're ready to deliver the best padlocks in the industry faster than ever before—available to ship in 48 hours. Customers can choose one-day, two-day or ground delivery, and be assured that the order will arrive keyed exactly as specified, in the style and color needed.

All these options are just another part of the American Lock advantage. Whatever level of security you need, you can count on American Lock to be your total security solutions provider. It's a name that's delivered for years: American Lock.



## SOLID STEEL PADLOCKS

### MAXIMUM SECURITY

American Lock® solid steel padlocks offer the highest protection of hardened steel. Our padlocks come in a wide range of widths, with shackle lengths and diameters to fit any application—great for outdoor protection of commercial buildings, industrial plants and perimeters, remote or unattended properties and high risk areas.

- The strongest padlock available—hardened, triple plated steel bodies resist break-in attempts, corrosion, rust and debris while the stainless steel double ball locking mechanism further assures the lock's strength and performance
- Hardened boron alloy shackles offer superior protection against cutting, while serrated cylinder pins resist picking
- Rekeyable five- or six-pin cylinders can be keyed differently, alike, master keyed or grand master keyed, with a variety of keyways



## SOLID STAINLESS STEEL PADLOCKS

### HIGHEST CORROSION RESISTANCE

American Lock stainless steel rectangular padlocks offer strong security with the highest resistance to harsh weather and extreme conditions. They are ideal for securing equipment and buildings in outdoor or corrosive environments, such as heavy-duty industrial or marine equipment and factories, and outdoor structures such as sheds, gates or other buildings. See page 9.

- Stainless steel bodies resist cutting, sawing and corrosion, and their stainless steel shackles provide superior weather and cut resistance
- Exceeds ASTM Grade 6 requirements for padlock corrosion resistance
- Five- and six-pin brass cylinders and serrated pins are pick resistant with tens of thousands of key changes

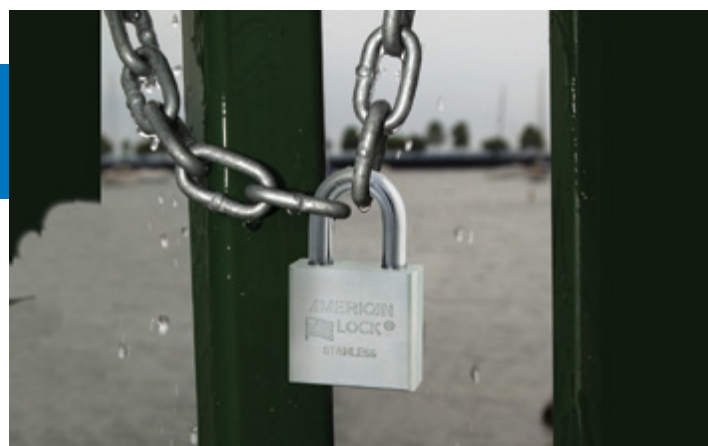

## REKEYABLE HIDDEN SHACKLE PADLOCKS

American Lock's round, heavy-duty, hidden shackle padlocks are the toughest padlocks of their type ever offered to security professionals. Our industrial-strength padlocks are rekeyable and have a replaceable cylinder and shackle.

- Padlocks offer maximum protection against drilling, sawing, prying, crowbars, dent pullers and hammers
- Six-pin tumbler cylinders provide superior pick resistance, with tens of thousands of key changes
- Ideal for high security areas and are adaptable for applications on garages, storage buildings, vehicles, commercial buildings, industrial plants and vending machines
- The three flat back locks, models A2500, A2010 and A2001, are tapped and threaded to attach to either high security hasp A801 or A802, featured on page 23. When affixed, for swing door applications, the combination provides both maximum security by making it virtually impossible to pry the lock away from the hasp and greater convenience, as the lock remains attached to the hasp when unlocked
- Choose bundle packs that combine the lock with patent-pending high security hasps for greater convenience and physical security – defying bolt cutters and prying

### A800LHC

This model combines the A2000 stepped back die cast lock with the A800 cast steel hasp.



A800LHC

### A2010

This lock is precision machined from high quality solid steel bar and triple plated for superior rust resistance. For maximum security, this lock features a flat back design so it can be fastened to the high security hasps, A801 and A802, featured on page 23.



A2010

Specifications		
Padlocks	A800LHC	A2010
Lock Material	Die Cast	Solid Steel
Lock Style	Stepped Back	Flat Back
Hasp Dimensions	9-1/16" x 4-1/2" (230mm x 114mm)	8-3/4" x 4-1/2" (222mm x 114mm)

**Keying Options – Keyed Alike (KA), Keyed Different (KD), Master Keyed (MK), BumpStop®, Edge®**

## LOCKING BOLT

Steel Throw Locking Bolt features a 3/4in (19mm) hardened steel locking bolt for maximum strength and is full adjustable from 3/4in (19mm) to 2-3/8in (60mm). Bolt is chrome plated for corrosion resistance and the mounting hardware is included for easy installation.

### A895 8-1/2in (21.6cm) Locking Bolt

- 3/4" hardened steel locking bolt for maximum strength
- Chrome plated for corrosion resistance; mounting hardware included
- Fully adjustable from 3/4" to 2-3/8"
- Accepts padlocks with 7/16" diameter shackle
- Mounting hardware included

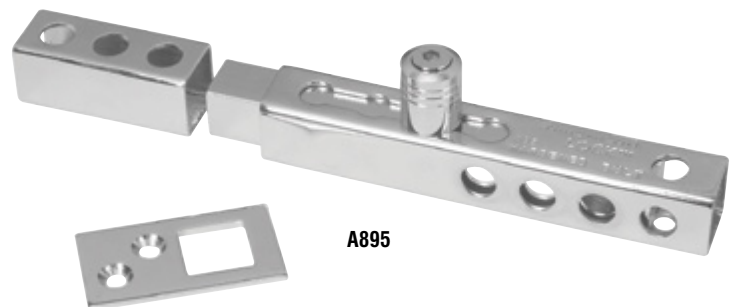

A895



## REKEYABLE SOLID STEEL PADLOCKS

These padlocks offer the greatest security and fit for real world applications. They're virtually indestructible with hardened, chrome plated solid steel bodies that resist cutting, sawing and corrosion and hardened boron alloy steel shackles that offer superior cut resistance.

- Hardened stainless steel serrated pins (A790, A780 & A748 only) in five- and six-pin brass cylinders and dual ball bearing locking mechanisms resist picking, pulling and prying
- Rekeyable, with replaceable cylinder and shackle, making them easy to service
- Great for security gates, sheds, truck and van doors, industrial machinery and construction equipment

### Round Body Padlocks

The American Lock original, the A700 series locks offer superior security.

**For all:** body width=2-1/2" (63mm), body thickness=1-1/8" (28mm), shackle diameter=7/16" (11mm), and horizontal clearance=15/16" (24mm)

Specifications	Chrome Plated Models		Zinc Plated Models	
	A700	A701	A702	A703
5-pin / APTC12	A700	A701	A702	A703
6-pin / APTC14	A706	A707		
Shackle Height	1-1/16" (27mm)	2" (50mm)	1-1/16" (27mm)	2" (50mm)

**Keying Options – Keyed Alike (KA), Keyed Different (KD), Master Keyed (MK), BumpStop®, Edge®**





## Shrouded Padlocks

Shackle shrouds offer the greatest protection against cutting and prying attacks.  
**Stainless steel shackles available (SS)**

### A5360 and A6360 Series

**For all:** body width=2" (50mm), body thickness=3/4" (19mm), shackle diameter=3/8" (10mm), and horizontal clearance=3/4" (19mm)

### A5300 and A6300 Series

**For all:** body width=1-3/4" (44mm), body thickness=3/4" (19mm), shackle diameter=5/16" (8mm), and horizontal clearance=3/4" (19mm)

Specifications	Models		
5-pin / APTC12		<b>A5360</b>	<b>A5300</b>
6-pin / APTC14		<b>A6360</b>	<b>A6300</b>
Shackle Height	1" (25mm)	1-1/8" (28mm)	

**Keying Options – Keyed Alike (KA), Keyed Different (KD), Master Keyed (MK), BumpStop®**

## 2" (50mm) Rectangular Padlocks

Weather Tough® Padlock Protection available.

**Stainless steel shackles available (SS)**

**For all:** body width=2" (50mm), body thickness=3/4" (19mm), shackle diameter=3/8" (10mm), and horizontal clearance=3/4" (19mm)

Specifications	Models		
5-pin / APTC12	<b>A5260</b>	<b>A5261</b>	<b>A5262</b>
6-pin / APTC14	<b>A6260</b>	<b>A6261</b>	<b>A6262</b>
Shackle Height	1-1/8" (28mm)	2" (50mm)	3" (75mm)

**Keying Options – Keyed Alike (KA), Keyed Different (KD), Master Keyed (MK), BumpStop®, Edge®**

## 1-3/4" (44mm) Rectangular Padlocks

Weather Tough® Padlock Protection available.

**Stainless steel shackles available (SS)**

**For all:** body width=1-3/4" (44mm), body thickness=3/4" (19mm), shackle diameter=5/16" (10mm), and horizontal clearance=3/4" (19mm)

Specifications	Models			
5-pin / APTC12	<b>A5200</b>	<b>A5201</b>	<b>A5202</b>	<b>A5205</b>
6-pin / APTC14	<b>A6200</b>	<b>A6201</b>	<b>A6202</b>	<b>A6205</b>
Shackle Height	1-1/8" (28mm)	2" (50mm)	3" (75mm)	5" (127mm)

**Keying Options – Keyed Alike (KA), Keyed Different (KD), Master Keyed (MK), BumpStop®, Edge®**

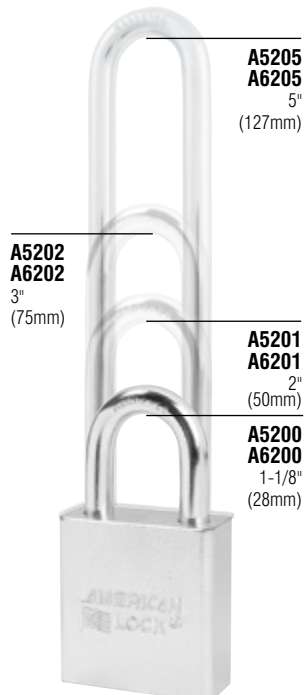
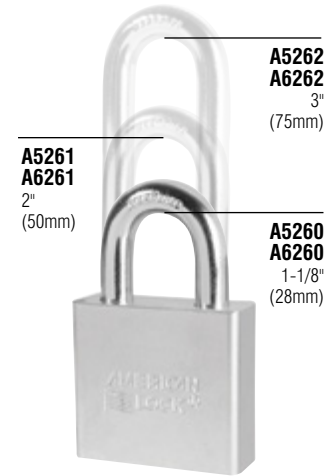

## 1-1/2" (38mm) Rectangular Padlocks

**For all:** body width=1-1/2" (38mm), body thickness=3/4" (19mm), shackle diameter=1/4" (6mm), and horizontal clearance=3/4" (19mm)

Specifications	Models		
5-pin / APTC12	<b>A5100</b>	<b>A5101</b>	<b>A5102</b>
6-pin / APTC14	<b>A6100</b>	<b>A6101</b>	<b>A6102</b>
Shackle Height	1" (25mm)	1-1/2" (38mm)	3" (75mm)

**Keying Options – Keyed Alike (KA), Keyed Different (KD), Master Keyed (MK), BumpStop®, Edge®**

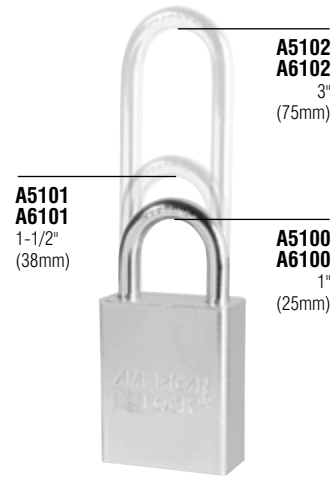

## REKEYABLE SOLID STAINLESS STEEL PADLOCKS

Weatherbuilt™ Padlock Protection available.

### A5400 and A6400

**For all:** body width=1-3/4" (44mm), body thickness=3/4" (19mm), shackle diameter = 5/16" (8mm) and horizontal clearance=3/4" (19mm)

### A5460 and A6460

**For all:** body width=2" (50mm), body thickness=3/4" (19mm), shackle diameter = 3/8" (10mm) and horizontal clearance=3/4" (19mm)

Specifications	Models	
5-pin / APTC12	<b>A5400</b>	<b>A5401</b>
	<b>A5460</b>	<b>A5461</b>
6-pin / APTC14	<b>A6400</b>	<b>A6401</b>
	<b>A6460</b>	<b>A6461</b>
Shackle Height	1-1/8" (28mm)	2" (50mm)

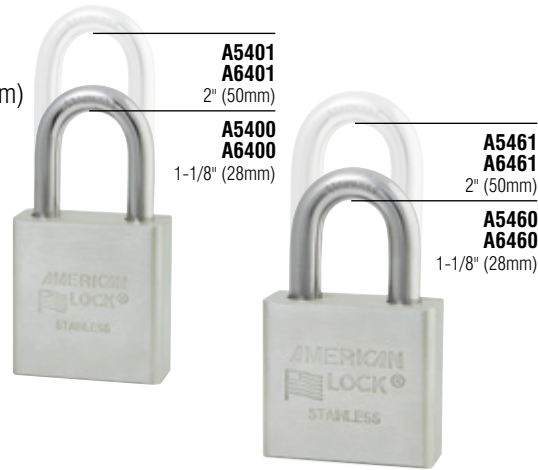

**Keying Options – Keyed Alike (KA), Keyed Different (KD), Master Keyed (MK), BumpStop®, Edge®**

## NON-REKEYABLE SOLID STEEL PADLOCKS

Designed to secure job boxes and other heavy duty applications. Non-serviceable five-pin APTC12 cylinder can be factory keyed to your requirements.

### A50HS

Fits Knaack and Watchman IV job boxes and has stainless steel pins for additional drill resistance.

**For all:** body width=2" (50mm), body thickness=7/8" (22mm), shackle diameter=3/8" (10mm) and horizontal clearance=3/4" (19mm)

Specifications	Models		
5-pin / APTC12	<b>A50</b> <b>A50HS</b>	<b>A51</b>	<b>A52</b>
Shackle Height	1-1/8" (28mm)	2" (50mm)	3" (75mm)

**Keying Options – Keyed Alike (KA), Keyed Different (KD), Master Keyed (MK), BumpStop®, Edge®**



## BLADE CYLINDER SOLID STEEL PADLOCKS

Rekeyable, disc tumbler cylinders perform extremely well in external applications— dirt and debris more easily pass through the cylinder and wafers, so the lock does not clog and continues to operate well.

### AH10, AH11

Chrome plated solid steel with nickel plated shackles

### AH100PB, AH110PB

Orange powder coated body and orange rubber bumper

**For all:** body width=2" (50mm), shackle diameter=7/16" (11mm), and horizontal clearance=3/4" (19mm)



Specifications	Models	
ABTC1	<b>AH10</b>	<b>AH11</b>
Shackle Height	1-1/16" (27mm)	2" (50mm)

**Keying Options – Keyed Alike (KA), Keyed Different (KD)**

## TUBULAR CYLINDER SOLID STEEL PADLOCKS

Pick resistant, rekeyable seven-pin tubular cylinders provide more than 50,000 key changes and meet National Automatic Merchandising Association (NAMA) requirements. **Stainless steel shackles available (SS)**

### A7300 Series

**For all:** body width=2-1/4" (57mm), body thickness=7/8" (22mm), shackle diameter=7/16" (11mm), and horizontal clearance=15/16" (24mm)

### A7260 Series

**For all:** body width=2" (50mm), body thickness=7/8" (22mm), shackle diameter=3/8" (10mm), and horizontal clearance=3/4" (19mm)

### A7200 Series

**For all:** body width=1-3/4" (44mm), body thickness=7/8" (22mm), shackle diameter=5/16" (8mm), and horizontal clearance=3/4" (19mm)



Specifications	Models				
7-pin / AHTC2	<b>A7300</b> <b>A7260</b> <b>A7200</b>	<b>A7301</b> <b>A7261</b> <b>A7201</b>	<b>A7262</b> <b>A7202</b>	<b>A7205</b>	
Shackle Height	1-1/8" (28mm)	2" (50mm)	3" (75mm)	5" (127mm)	

**Keying Options – Keyed Alike (KA), Keyed Different (KD)**

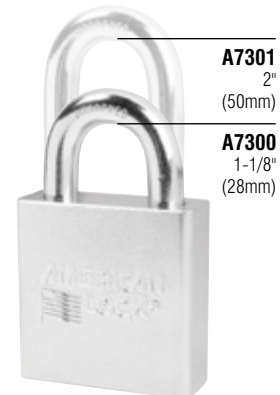



## SOLID BRASS PADLOCKS

### CORROSION-RESISTANT SECURITY

American Lock® solid brass padlocks resist salt water and other moisture, offering ideal protection to equipment and buildings in even the harshest outdoor environments and corrosive atmospheres. They're excellent for protecting marine equipment, industrial plants and perimeters, sheds, gates and outbuildings. As with all American Lock products, brass padlocks come in a full spectrum of widths, with shackle diameters and lengths to meet the needs of all users.

- Hardened boron alloy shackles offer superior cut resistance, while dual stainless steel ball bearing locking mechanism resists pulling and prying
- Shackles are chrome plated for corrosion resistance—rust-resistant brass shackles available for marine applications
- Five- and six-pin brass cylinders and serrated pins are pick resistant with tens of thousands of key changes
- Can meet all keying requirements—brass five- or six-pin cylinders can be keyed differently, alike, master keyed or grand master keyed, with a variety of keyways



## REKEYABLE SOLID BRASS PADLOCKS

### 2" (50mm) Rectangular Padlocks

Weather Tough® Padlock Protection available. **Brass shackles available (B)**  
**Stainless steel shackles available (SS)**

**For all:** body width=2" (50mm), body thickness=3/4" (19mm),  
 shackle diameter=3/8" (10mm), and horizontal clearance=3/4" (19mm)

Specifications	Models		
5-pin / APTC12	<b>A5570</b>	<b>A5571</b>	<b>A5572</b>
6-pin / APTC14	<b>A6570</b>	<b>A6571</b>	<b>A6572</b>
Shackle Height	1-1/8" (28mm)	2" (50mm)	3" (75mm)

**Keying Options – Keyed Alike (KA), Keyed Different (KD), Master Keyed (MK),  
 BumpStop®, Edge®**



### 1-3/4" (44mm) Rectangular Padlocks

Weather Tough® Padlock Protection available. **Brass shackles available (B)**  
**Stainless steel shackles available (SS)**

**For all:** body width=1-3/4" (44mm), body thickness=3/4" (19mm),  
 shackle diameter=5/16" (8mm), and horizontal clearance=3/4" (19mm)

Specifications	Models			
5-pin / APTC12	<b>A5560</b>	<b>A5561</b>	<b>A5562</b>	<b>A5565</b>
6-pin / APTC14	<b>A6560</b>	<b>A6561</b>	<b>A6562</b>	<b>A6565</b>
Shackle Height	1-1/8" (28mm)	2" (50mm)	3" (75mm)	5" (127mm)

**Keying Options – Keyed Alike (KA), Keyed Different (KD), Master Keyed (MK),  
 BumpStop®, Edge®**



### 1-1/2" (38mm) Rectangular Padlocks

**Brass shackles available (B)**

**For all:** body width=1-1/2" (38mm), body thickness=3/4" (19mm),  
 shackle diameter=1/4" (6mm), and horizontal clearance=3/4" (19mm)

Specifications	Models		
5-pin / APTC12	<b>A5530</b>	<b>A5531</b>	<b>A5532</b>
6-pin / APTC14	<b>A6530</b>	<b>A6531</b>	<b>A6532</b>
Shackle Height	1" (25mm)	1-1/2" (38mm)	3" (75mm)

**Keying Options – Keyed Alike (KA), Keyed Different (KD), Master Keyed (MK),  
 BumpStop®, Edge®**



## NON-REKEYABLE SOLID BRASS PADLOCKS

Non-serviceable five-pin APTC12 cylinder can be factory keyed to your requirements.

### Brass shackles available (B)

#### A20 Series

Weather Tough® Padlock Protection available.

#### Stainless steel shackles available (SS)

**For all:** body width=1-3/4" (44mm), body thickness=3/4" (19mm), shackle diameter=5/16" (8mm), and horizontal clearance=3/4" (19mm)

#### A40 Series

**For all:** body width=1-1/2" (38mm), body thickness=3/4" (19mm), shackle diameter=1/4" (6mm), and horizontal clearance=3/4" (19mm)



Specifications	Models				
5-pin / APTC12	<b>A40</b>	<b>A20</b>	<b>A41</b>	<b>A21</b>	<b>A22 A42</b>
Shackle Height	1" (25mm)	1-1/8" (28mm)	1-1/2" (38mm)	2" (50mm)	3" (75mm)

**Keying Options – Keyed Alike (KA), Keyed Different (KD), Master Keyed (MK), BumpStop®, Edge®**

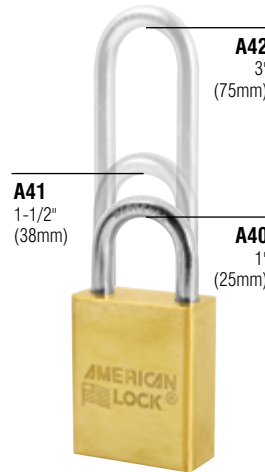
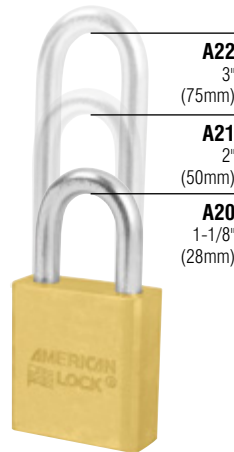

## BLADE CYLINDER SOLID BRASS PADLOCKS

Rekeyable, disc tumbler cylinders perform extremely well in external applications—dirt and debris more easily pass through the cylinder and wafers, so the lock does not clog and continues to operate well. **Brass shackles available (B)**

### Stainless steel shackles available (SS)

#### 1-3/4" (44mm) Rectangular Padlocks

**For all:** body width=1-3/4" (44mm), body thickness=3/4" (19mm), shackle diameter=5/16" (8mm), and horizontal clearance=3/4" (19mm)

Specifications	Models			
ABTC1	<b>AL50</b>	<b>AL51</b>	<b>AL52</b>	<b>AL55</b>
Shackle Height	1-1/8" (28mm)	2" (50mm)	3" (75mm)	5" (127mm)

**Keying Options – Keyed Alike (KA), Keyed Different (KD)**

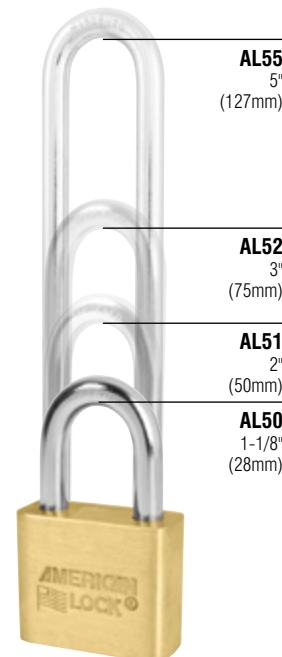



## SOLID ALUMINUM PADLOCKS

### SAFETY LOCKOUT AND DURABLE SECURITY

Our top-selling lightweight, solid aluminum padlocks were an industry breakthrough when introduced and continue to be a top seller. American Lock's aluminum line is offered in nine anodized finishes for easy identification as well as in a full range of widths, with many shackle diameters and lengths available. Our aluminum padlocks can stand up to caustic environments and are best for lockout/tagout uses, utility storage areas, sheds, gates and outbuildings.

- Made from an exclusive aluminum alloy, offering strong protection similar to brass in harsh and corrosive environments
- Lightweight, durable padlocks are ideal to carry from lockout job to lockout job
- All have a sturdy anodized finish, which is perfect for food processing applications
- Most come with hardened boron alloy steel shackles for superior cut resistance and chrome plated for extra corrosion resistance—brass shackle option is offered on some models
- Dual ball bearing locking mechanism resists pulling and prying
- Laser engraving option lets companies permanently add employee information on padlocks for lockout identification compliance



## SAFETY LOCKOUT PADLOCKS, IDENTIFICATION AND HASPS

### 1-1/2" (38mm) Rekeyable Rectangular Padlocks

- Lightweight, durable padlocks are easy to carry from one lockout job to the next
- Choice of nine colors to organize by department: black (BLK), blue (BLU), brown (BRN), clear (CLR), green (GRN), orange (ORJ), purple (PRP), red (RED), yellow (YLW)
- Anodized, durable finish is fused to the lock surface and will not chip, making it ideal for food processing facilities; easily withstands washdown chemicals and caustic environments
- Brass shackle option enhances spark resistance
- Exclusive-to-safety W401 keyway (W417 for Master Keyed systems) with deeper pins and key cut depths minimizes inadvertent key interchange caused by years of hard use. More than 40,000 unique codes assure no duplication in a facility
- Laser engraving option lets companies permanently add employee information on padlocks for lockout identification compliance

**For all:** body width=1-1/2" (38mm), body thickness=3/4" (19mm), shackle diameter=1/4" (6mm), and horizontal clearance=3/4" (19mm)

Specifications	Models		
W401 Safety	<b>S1105</b>	<b>S1106</b>	<b>S1107</b>
W417 Safety*	<b>S1105MK</b>	<b>S1106MK</b>	<b>S1107MK</b>
5-pin / APTC12	<b>A1105</b>	<b>A1106</b>	<b>A1107</b>
6-pin / APTC14	<b>A1165</b>	<b>A1166</b>	<b>A1167</b>
Shackle Height	1" (25mm)	1-1/2" (38mm)	3" (75mm)

\*W417 for MK and KAMK models only

**Keying Options – Keyed Alike (KA), Keyed Different (KD), Master Keyed (MK), BumpStop<sup>®</sup>, Edge<sup>®</sup>**

### Padlock Identification Labels

**Photo ID Labels –** Personalize the S1100/A1100 Series safety padlocks in your facility to make the user immediately recognizable.

**Write-on Labels –** Customize the S1100/A1100 Series safety lockout padlocks with worker name and department.

### Safety Lockout Hasps

Steel lockout hasps in popular scissors style feature locking tabs for extra pry resistance. Red PVC-free coating on handle identifies safety application. Two sizes available to fit most applications.

Specifications	Models	
	<b>ALO80</b>	<b>ALO802</b>
Jaw Diameter	1" (25mm)	1-1/2" (38mm)



A full line of safety lockout devices is available at [www.masterlocksafety.com](http://www.masterlocksafety.com).



## REKEYABLE SOLID ALUMINUM PADLOCKS

Available in nine different colors: black (BLK), blue (BLU), brown (BRN), clear (CLR), green (GRN), orange (ORJ), purple (PRP), red (RED), yellow (YLW).

Weather Tough® Padlock Protection available;

**Brass shackles available (B)**

**Stainless steel shackles available (SS)**

### 2" (50mm) Rectangular Padlocks

**For all:** body width=2" (50mm), body thickness=3/4" (19mm)  
shackle diameter=3/8" (10mm), and horizontal clearance=3/4" (19mm)

Specifications	Models		
5-pin / APTC12	<b>A1305</b>	<b>A1306</b>	<b>A1307</b>
6-pin / APTC14	<b>A1365</b>	<b>A1366</b>	<b>A1367</b>
Shackle Height	1-1/8" (28mm)	2" (50mm)	3" (75mm)

**Keying Options – Keyed Alike (KA), Keyed Different (KD), Master Keyed (MK), BumpStop®, Edge®**

### 1-3/4" (44mm) Rectangular Padlocks

**For all:** body width=1-3/4" (44mm), body thickness=3/4" (19mm),  
shackle diameter=5/16" (8mm), and horizontal clearance=3/4" (19mm)

Specifications	Models			
5-pin / APTC12	<b>A1205</b>	<b>A1206</b>	<b>A1207</b>	<b>A1209</b>
6-pin / APTC14	<b>A1265</b>	<b>A1266</b>	<b>A1267</b>	<b>A1269</b>
Shackle Height	1-1/8" (28mm)	2" (50mm)	3" (75mm)	5" (127mm)

**Keying Options – Keyed Alike (KA), Keyed Different (KD), Master Keyed (MK), BumpStop®, Edge®**

## NON-REKEYABLE SOLID ALUMINUM PADLOCKS

Non-serviceable five-pin APTC12 cylinder can be factory keyed to your requirements. **Brass shackles available (B)**

### 1-3/4" (44mm) Rectangular Padlocks

Weather Tough® Padlock Protection available;

**Stainless steel shackles available (SS)**

**For A10 Series:** body width=1-3/4" (44mm),  
body thickness=3/4" (19mm), shackle diameter=5/16" (8mm),  
and horizontal clearance=3/4" (19mm)

### 1-1/2" (38mm) Rectangular Padlocks

**For A30 Series:** body width=1-1/2" (38mm),  
body thickness=3/4" (19mm), shackle diameter=1/4" (6mm),  
and horizontal clearance=3/4" (19mm)

Specifications	Models				
5-pin / APTC12	<b>A30</b>	<b>A10</b> <b>A10SS</b>	<b>A31</b>	<b>A11</b> <b>A11SS</b>	<b>A12</b> <b>A32</b>
Shackle Height	1" (25mm)	1-1/8" (28mm)	1-1/2" (38mm)	2" (50mm)	3" (75mm)

**Keying Options – Keyed Alike (KA), Keyed Different (KD), Master Keyed (MK), BumpStop®, Edge®**

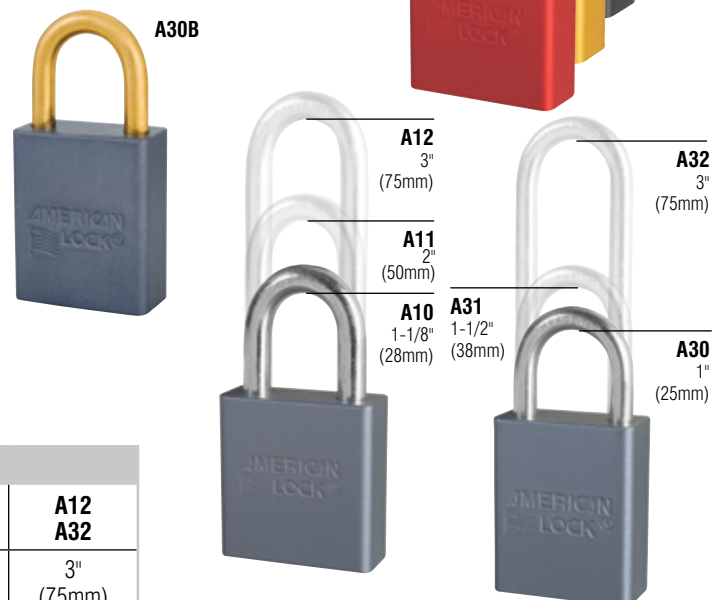



## GOVERNMENT PADLOCKS

American Lock® padlocks offer unsurpassed quality and superior performance, exceeding commercial industry standards. These padlocks protect assets at facilities throughout the world, securing high-value property, withstanding extensive use and harsh environments, and defeating attempts to breach security. American Lock brings this pride and workmanship to our padlocks, made to exacting government standards.

For over 65 years, American Lock has provided security solutions to every segment of the U.S. government and military defense agencies. With our unmatched line of security products, American Lock has more than 60 National Stocking Numbers (NSNs) assigned to our product line to meet government requirements.

Our A5200GLN and ASL40N solid body government locks are designed to stringent government standards CID-A-A-59486 and CID-A-A-59487. They feature a five-pin tumbler cylinder for more than 10,000 key changes and a dual locking mechanism for superior pry resistance. For added security, all models have non-removable keys.

American Lock government padlocks can be ordered by NSN or by Commercial Part Number. Additional variations are available to be built to your specific requirements:

- Combine individual locks into custom sets consisting of any quantity or keying combination
- Padlocks can be keyed alike or master keyed
- Available with extra length shackles and laser engraved marking on ASL40N and A5560N Locks
- Chain attachments available to attach to shackle so lock cannot be removed
- Brass shackle options, available on brass padlocks, offer extra protection against the elements
- Government padlocks use an Advanced Cylinder Technology to resist bump attacks

Please visit our Government Padlock section of [www.americanlock.com](http://www.americanlock.com) or see the Government price list for the full NSN listing.



### Solid Steel Rectangular Padlocks

Solid steel locks have a zinc chromate finish. Available with chains (W) attached to the shackle. **Stainless steel shackles available (SS)**

### Shrouded Padlocks

Shackle shrouds offer the greatest protection against cutting and prying attacks.

**For A5200GLN Series:** body width=1-3/4" (44mm), body thickness=3/4" (19mm), shackle diameter=5/16" (8mm), and horizontal clearance=3/4" (19mm)

Specifications	Models		
5-pin	<b>A5200GLN</b> <b>A5200GLSHN</b> <b>A5200GLWN</b>	<b>A5201GLN</b> <b>A5201GLWN</b>	<b>A5202GLN</b> <b>A5202GLWN</b>
Shackle Height	1-1/8" (28mm)	2" (50mm)	3" (75mm)

**Keying Options – Keyed Alike (KA), Keyed Different (KD), Master Keyed (MK)**

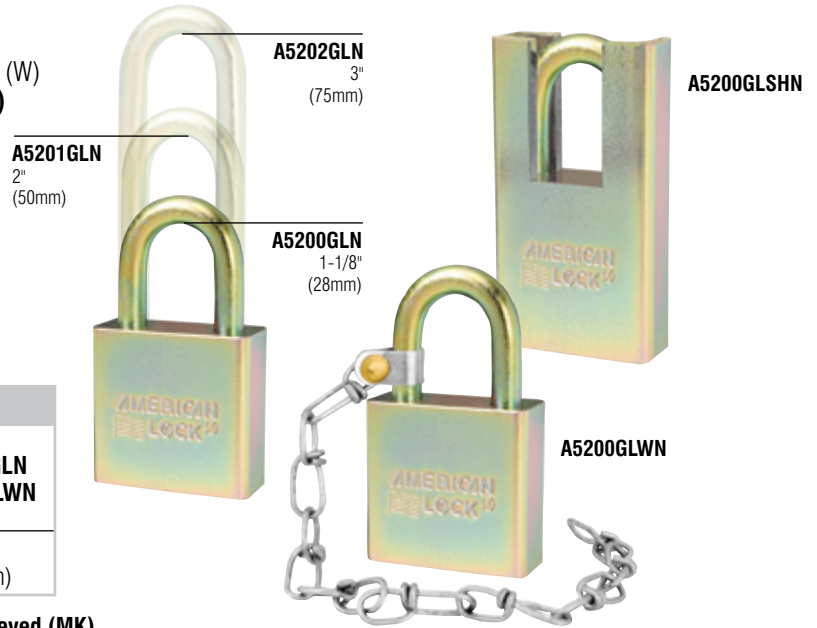

### Solid Brass Rectangular Padlocks

Solid brass locks are available in two body widths with choice of hardened steel or brass shackle.

**For A5560NB Series:** body width=1-3/4" (44mm), body thickness=3/4" (19mm), shackle diameter=5/16" (8mm), and horizontal clearance=3/4" (19mm)

**For ASL40N Series:** body width=1-1/2" (38mm), body thickness=3/4" (19mm), shackle diameter=1/4" (6mm), and horizontal clearance=3/4" (19mm)

Specifications	Models		
5-pin	<b>ASL40N</b>		<b>ASL42N</b>
5-pin		<b>A5560N</b>	
Shackle Height	1" (25mm)	1-1/8" (28mm)	3" (75mm)

**Keying Options – Keyed Alike (KA), Keyed Different (KD), Master Keyed (MK)**



# DOOR KEY COMPATIBLE CYLINDERS AND PADLOCKS



## SECURITY OPTIONS

Just one key can open them all. American Lock's door key compatible cylinders and padlocks mean the same key system can be used for all doors and padlocks—for greater key control, security, affordability and convenience.

- Padlock bodies accept the Edge® Key Control cylinder as well as the following OEM cylinders: Medeco® #20W20000 six-pin cylinder; Schlage® six-pin key-in-knob; Assa® #65611; Lori® #1539; and Schlage® Primus® and GMS® cylinders
- Changing keyways is easy—with many keyways available, most door security systems can be easily matched
- Recreate and/or expand any current key system using existing records
- Order cylinders both as part of a complete American Lock door key compatible padlock assembly, or separately, keyed up and ready to use
- WO comes standard with drivers to accommodate Medeco®, Lori®, 1539 and Schlage® cylinders

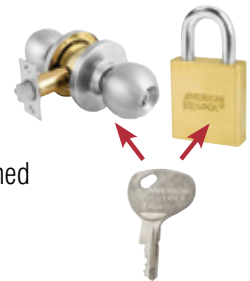

## DOOR KEY COMPATIBLE PADLOCKS

With hardened boron alloy shackles, our door key compatible padlocks offer superior resistance against bolt cutters and prying, while the dual ball bearing locking mechanism resists pulling and prying. Padlocks are rekeyable, with replaceable cylinders and shackles.

### Solid Steel Padlocks

Solid steel padlocks are made of hardened steel and are chrome plated—resisting cutting, sawing and corrosion.

**For 3800 Series:** body width=2-1/4" (57mm), body thickness=3/4" (19mm), shackle diameter=7/16" (11mm), and horizontal clearance=15/16" (24mm)

### Solid Brass Padlocks

Solid brass padlocks are corrosion resistant and ideal for harsh environments. **Brass shackles available (B)**

**For 3700 Series:** body width=2" (50mm), body thickness=3/4" (19mm), shackle diameter=3/8" (10mm), and horizontal clearance=3/4" (19mm)

**For 3600 Series:** body width=1-3/4" (44mm), body thickness=3/4" (19mm), shackle diameter=5/16" (8mm), and horizontal clearance=3/4" (19mm)



Specifications	Models		
	A3800 A3700 A3700SS	A3801 A3701 A3701SS	A3702
Shackle Height	1-1/8" (28mm)	2" (50mm)	3" (75mm)

**Keying Options – Keyed Alike (KA), Keyed Different (KD), Master Keyed (MK), BumpStop®, Edge®**

**WO – Without Cylinder**

## A3650 SERIES MULTI-CYLINDER PADLOCK

The American Lock No. A3650 multi-cylinder padlock is one of the most versatile padlocks available. The 1-3/4in (44mm) wide solid brass body, dual ball bearing design and boron alloy shackle provide strong defense against physical attacks and offer superior weather resistance. The quick-change shackle and key-retaining features provide convenience, ease of use and time savings. This single lock body accepts 9 different key-in-knob (KIK) and padlock cylinders, enabling users to streamline service inventories and simplify operations.

- 1-3/4in (44mm) solid brass body for maximum corrosion resistance
- 1-1/8in (28mm) tall, 5/16in (8mm) diameter hardened boron alloy shackle for superior cut resistance
- Accepts 9 different types of common KIK and padlock cylinders
- Easily change key-retaining function without disassembling lock
- Quickly change shackle without disassembling lock
- Backed by full-factory keying and lock customization services

Item Number	Keyway	Shackle Description
A3650D035	Yale 8	1-1/8in (28mm) Chrome-Plated Boron Shackle
A3650D045	Schlage C	
A3650D125	Kwikset	
A3650D285	Schlage P	
A3650W0	No cylinder - includes KIK accessory pack	

**Keying Options – Keyed Alike (KA), Keyed Different (KD), Master Keyed (MK), Zero-bitted (KZ)**



## SERVICE KITS

Our lock service kits include critical component parts and service tools including pins, springs, shackles, cylinders, actuators, trap doors, key gauges and followers. With these kits, locks can be keyed and rekeyed to meet customer system requirements. The service parts are available separately to replenish kits.

**ASK8** Pin Tumbler Service Kit

**APK1** Pin Tumbler Pinning Kit



# INTERCHANGEABLE CORES AND PADLOCKS



American Lock® offers small and large format interchangeable core padlocks designed to accept other manufacturer's cylinders so anyone can easily and affordably fit them into an established keying system. SFIC padlock bodies also will accept the following OEM cores: Arrow®, Best®, Best® PKS, Falcon®, Kaba® Peaks®, KSP® and Lori®.

- Changing cores is simple—match a door security system with 16 small format interchangeable core keyways, including Best®, Arrow® and Falcon®
- Recreate and/or expand a current key system using existing records
- Order cores both as part of a complete American Lock interchangeable core padlock assembly, or separately, keyed up and ready to use with any system

## INTERCHANGEABLE CORE PADLOCKS

With hardened boron alloy shackles, our door key compatible padlocks offer superior resistance against bolt cutters and prying, while the dual ball bearing locking mechanism resists pulling and prying. Padlocks are rekeyable, with replaceable cylinders and shackles.

## SMALL FORMAT INTERCHANGEABLE CORE PADLOCKS

Padlocks accept six- and seven-pin cores with no spacers required.

### Solid Steel Padlocks

Solid steel padlocks are made of hardened steel and are chrome plated—resist cutting, sawing and corrosion. Available with Weather Tough® Padlock Protection;

**Stainless steel shackles available (SS)**

**For A3260 Series:** body width=2" (50mm), body thickness=3/4" (19mm), shackle diameter=3/8" (10mm), and horizontal clearance=3/4" (19mm)

**For A3200 Series:** body width=1-3/4" (44mm), body thickness=3/4" (19mm), shackle diameter=5/16" (8mm), and horizontal clearance=3/4" (19mm)

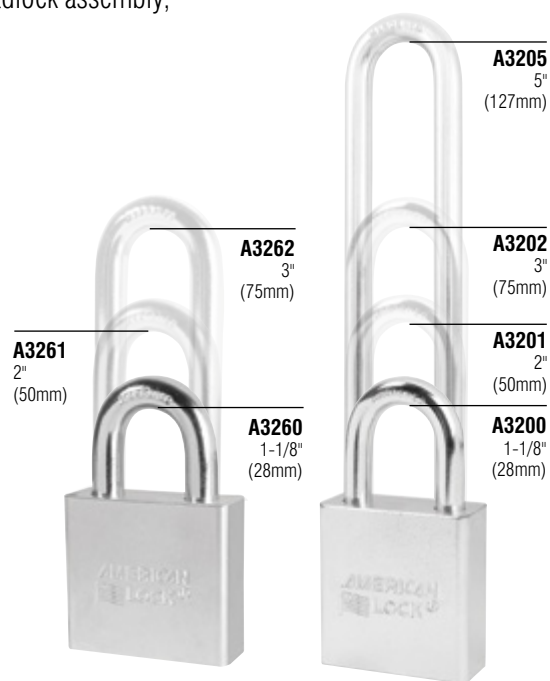

Specifications	Models			
	A3260 A3200	A3261 A3201	A3262 A3202	A3205
Shackle Height	1-1/8" (28mm)	2" (50mm)	3" (75mm)	5" (127mm)

**Keying Options – Keyed Alike (KA), Keyed Different (KD), Master Keyed (MK)**

### Solid Brass Padlocks

Solid brass padlocks are corrosion resistant and ideal for harsh environments; available with Weather Tough® Padlock Protection option.

#### Brass shackles available (B)

#### Stainless steel shackles available (SS)

**For 3570 Series:** body width=2" (50mm), body thickness=3/4" (19mm), shackle diameter=3/8" (10mm), and horizontal clearance=3/4" (19mm)

**For 3560 Series:** body width=1-3/4" (44mm), body thickness=3/4" (19mm), shackle diameter=5/16" (8mm), and horizontal clearance=3/4" (19mm)

Specifications	Models			
	A3570 A3560	A3571 A3561	A3572 A3562	A3565
Shackle Height	1-1/8" (28mm)	2" (50mm)	3" (75mm)	5" (127mm)

Keying Options – Keyed Alike (KA), Keyed Different (KD), Master Keyed (MK)

### Solid Aluminum Padlocks

Solid aluminum padlocks are available in nine anodized finishes for easy identification, and are lightweight and spark and corrosion resistant, ideal for harsh environments. **Brass shackles available (B)**

**For 3100 Series:** body width=1-1/2" (38mm), body thickness=3/4" (19mm), shackle diameter=1/4" (6mm), and horizontal clearance=3/4" (19mm)

Specifications	Model		
	A3105	A3106	A3107
Shackle Height	1" (25mm)	2" (50mm)	3" (75mm)

Keying Options – Keyed Alike (KA), Keyed Different (KD), Master Keyed (MK)

## LARGE FORMAT INTERCHANGEABLE CORE PADLOCKS

### Solid Brass Padlocks: Schlage® Everest® and Primus®

Solid brass padlocks resist corrosion; A3900S series accepts Schlage® Everest® and Primus® cores. **Stainless steel shackles available (SS)**

**For 3900 Series:** body width=2" (50mm), body thickness=3/4" (19mm), shackle diameter=3/8" (10mm), and horizontal clearance=3/4" (19mm)

Specifications	A3900S	A3901S	A3902S
Shackle Height	1-1/8" (28mm)	2" (50mm)	3" (50mm)

Keying Options – Keyed Alike (KA), Keyed Different (KD), Master Keyed (MK)

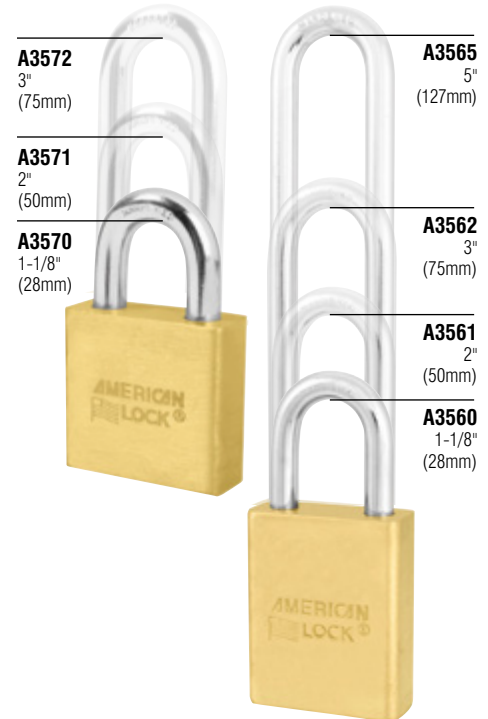

**INGENUITY • INDUSTRY • INTEGRITY**



Since 1912, American Lock® has been the brand of choice in security products for industry, government and commercial users worldwide, with premium padlocks that stand up both to attack and to the harshest environments. These qualities are what make American Lock “The Locksmith’s Lock.” With over 100 years of precision machining and quality manufacturing, American Lock products exceed commercial industry standards.



[www.americanlock.com](http://www.americanlock.com)

**AMERICAN  
LOCK®**

[www.americanlock.com](http://www.americanlock.com)

[www.masterlock.com](http://www.masterlock.com)

Master Lock Company LLC, Milwaukee, WI 53210 U.S.A. | 800-308-9244

Master Lock Canada, Mississauga, ON L5L 5Z9 Canada | 800-308-9244

©2021 Master Lock Company LLC | All Rights Reserved | Patents Pending

A-003 DPD 2.5M 07/21